

26 632 360



- shower with fixed riser projection 420mm
- overhead shower: rain flow
- rain shower Ø 200 mm
- rain shower with anti-scale system
- max. rainshower flow 6.8 l/min
- rotary diverter for fixed-riser shower/hand shower
- height of fittings up to top edge of elbow 1180mm
- height of fittings up to rain shower (bottom edge) 1009mm
- rosette for shower holder Ø 66mm
- rosette for wall mounting Ø 70mm
- rosette for shower mixer Ø 60mm
- gauge 150 mm - 13 mm
- metal shower hose 1250mm with integrated anti-twist protection
- 1/2" connection
- Pipe diameter 20 mm
- This product reduces water consumption by % (compared to requirements of EPAct '92)
- This product can contribute to Water Use Reduction in LEED® Green Building Rating
- This product can help a building meet the requirements of Green Building Rating Systems, e.g. LEED®, BREEAM®, DGNB







**Note: Local building codes may require the use of an anti-scald device. Please refer to remote pressure balance valve (35 910 970 90) Intrinsic protection against back flow.**

**NOTE: Hand shower sold separately. Please see hand shower options under the miscellaneous articles section of each series.**

Note: Local building codes may require the use of an anti-scald device. Please refer to remote pressure balance valve (35 910 970 90)

Intrinsic protection against back flow.

NOTE: Hand shower sold separately. Please see hand shower options under the miscellaneous articles section of each series.

	Chrome	26 632 360-00 0010
	Brushed Platinum	26 632 360-06 0010
	Platinum	26 632 360-08 0010
	Durabrace (23kt Gold)	26 632 360-09 0010
	Brushed Durabrace (23kt Gold)	26 632 360-28 0010
	Brushed Dark Platinum	26 632 360-99 0010

**Required miscellaneous**

	<b>Concealed adapter -</b> •please order two adapters (USA only)	35 080 970-90 0010
---	---	--------------------

**Required miscellaneous**

	<b>MADISON Metal hand shower with porcelain insert (white) FlowReduce - Chrome</b>	28 002 970-00 0010
---	--	--------------------

**Required miscellaneous**

	<b>MADISON Hand shower FlowReduce - Chrome</b> •spray head Ø 95mm •Hand shower see page {PAGE} •Three settings: COMPACT RAIN, COMPACT SOFT FLOW, COMPACT AQUAPRESSURE FLOW, max. flow rate l/min (at 3 bar)	28 002 978-00 0010
---	--	--------------------

26 632 360

mm [inches]

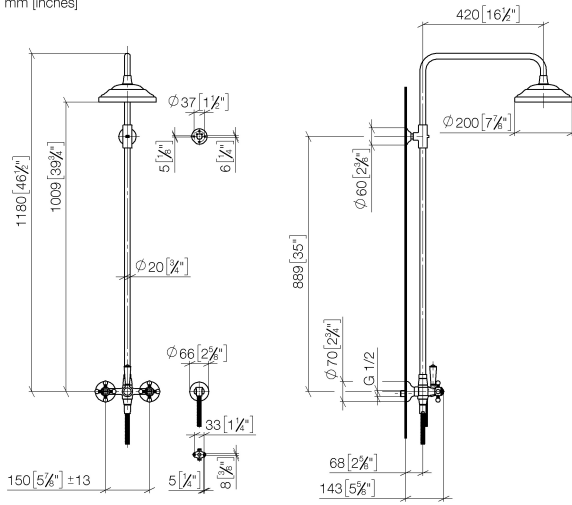

**Flow rate chart**

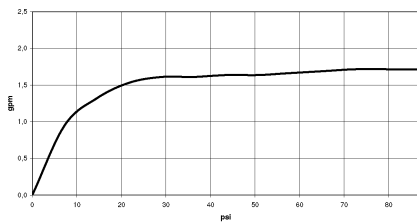

**Codes & Standards**

California Energy  
Commission  
(CEC)

26 632 360

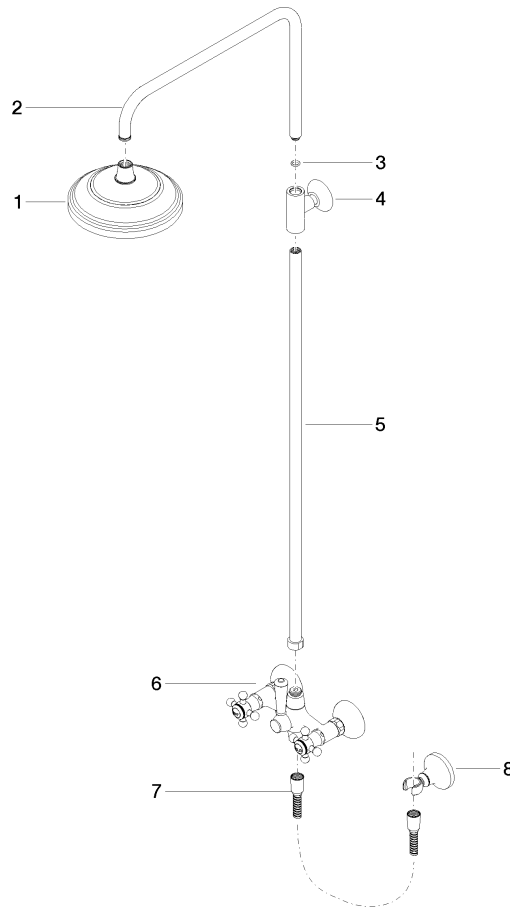

Spare parts list

No.	Item Number	Name	Quantity used	Delivery time
1	04 12 05 038 30-00	shower	1	10
2	04 28 22 101 20-00	spout	1	10
3	90 14 10 011 00 90	seal	1	2
4	90 17 11 033 00-00	holder	1	10
5	90 28 22 096 00-00	pipe	1	10
6	04 17 10 001 00-00	fitting	1	60
7	28 104 970-00	Metal shower hose 1/2" x 1/2" x 1250 mm - Chrome	1	2
8	28 050 410-00	holder	1	60